

# ZDWK-40

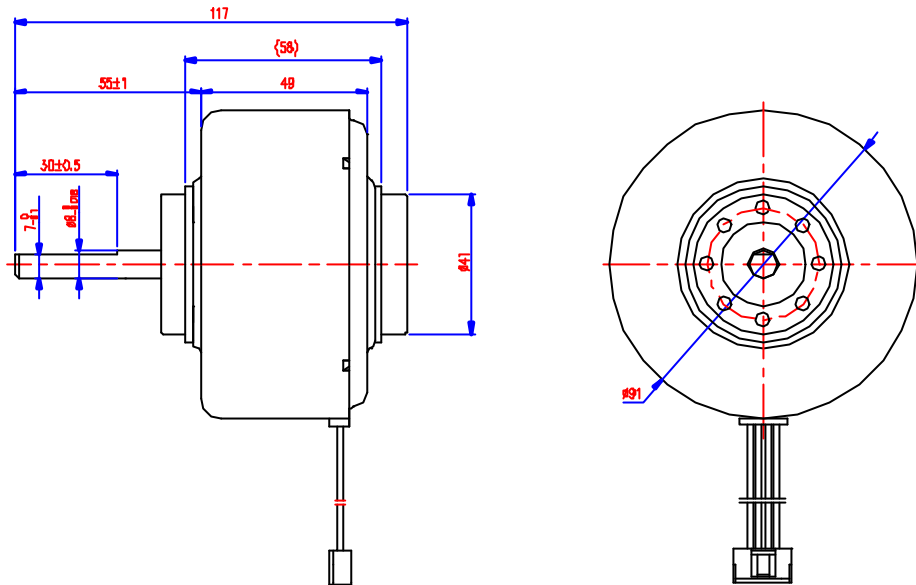

Motor Model	Speed at Max Efficiency (rpm)	Max-Operating Voltage (V)	Current at Max Efficiency (A)	Max Tourque ( N.m)	Use
ZDWK-40	1320	54	1.3	0.4	A/C Motor